

ASSORTMENT CATALOG

2024



MODULAR HOUSE CHAMÄLEON | MODULAR CONCRETE POSTS | FENCES | TRELLISES
FRONT YARD FENCES | PLAYGROUND EQUIPMENT | FENCE POSTS | CONSTRUCTION TIMBER | PERGOLAS | POSTS
PALISADES | PLANTERS | FUELS

WE ARE DIMPLEX



PAUL LAWNICZAK
CEO



RALF HACHEN
PROCURER, SALES MANAGER

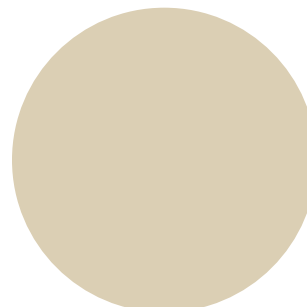

WIOLETTA CHMIEL
SALES



ANNA PIWKO-LETEK
SALES



MONIKA PLEWA
SALES



MARGARITA VULFERT
SALES



JOANA CZOLBE
SALES

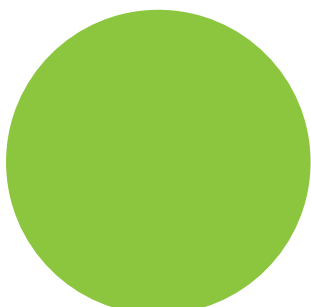
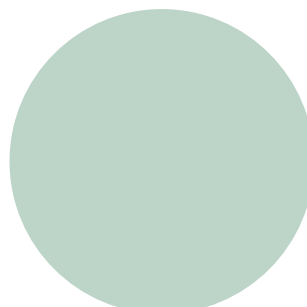

JENNY MÜLLER
FINANCE



RUTH KÜTTNER
FINANCE

04	NUMBERS AND FACTS
06	VISION & MISSION
08	MODULAR HOUSE CHAMÄLEON
12	MODULAR CONCRETE POSTS
14	LARCH OFFERING
18	VINTAGE-GREY OFFERING
20	FENCES & TRELISES
30	FRONT YARD FENCES
40	PLAYGROUND EQUIPMENT
50	FENCE POSTS & CONSTRUCTION TIMBER
56	PERGOLAS POSTS PALISADES PLANTERS RAISED BEDS COMPOSTER
64	FUELS
66	GOOD TO KNOW

CONTENTS

dimplex Garten GmbH
Hohe Kamp 46
D-33175 Bad Lippspringe

Tel.: +49 (0) 52 52-98 98 9-0
Fax: +49 (0) 52 52-98 98 9-20
E-Mail: kontakt@dimplex-garten.de

www.dimplex-garten.de



NUMBERS & FACTS

PRODUCTION

We have been producing garden products for more than 25 years

WAREHOUSE

Our central warehouse has a total size of more than 80.000 m²



CAPACITY

Up to 6.000 truckloads of garden products & fuels are delivered annually



dimplex  **ex**
Garden



FOUNDING

In 1996 Dimplex Import-Export GmbH was founded

CERTIFIED

We are PEFC-certified and follow a 0% residual material rule



VISION

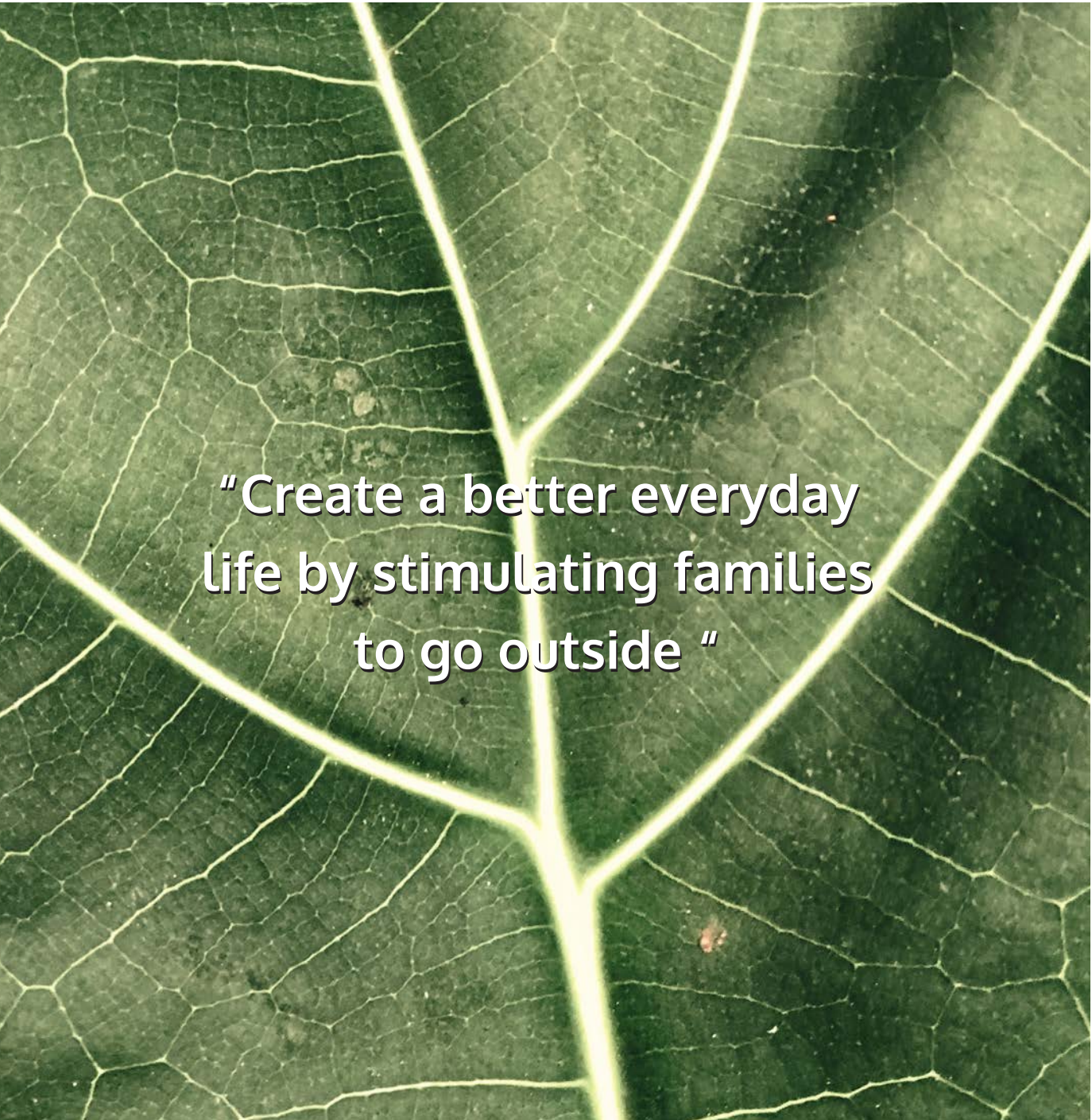

**"Create a better everyday
life by stimulating families
to go outside "**

MISSION

"We offer a large assortment of garden products that satisfy the needs of every family member for an affordable price, so that families can enjoy their garden together "



NEW



MODULAR HOUSE CHAMÄLEON

Let your customers utilize and experience their garden in new ways. Whether it will be an outdoor living room, a gym, a guest bedroom, or a comfortable home office, the possibilities are endless.

This modular system enables a versatile customization of the product in terms of size, layout, and look. The individual preferences and wishes of the customers are unlimited here.

DIMENSIONS

Depth	2,5 m / 3,0 m / 4,0 m
Length	3,1 m / 3,7 m / 4,3 m / 4,9 m / 5,5 m / 6,1 m
Height	2,45 m

MATERIALS

Posts	Glulam
Walls	Rhombus 3-layer board profiled timber
Glass	Safety glass 8 mm
Roof	EPDM

COLOR

- Natural
- Stained



CUSTOMIZATION

1. SIZE



2. LAYOUT

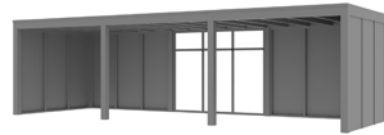

3. LOOK



OPTIONAL WALL DESIGNS



RHOMBUS-WALL
RAL1034



RHOMBUS-WALL
RAL9010



WOOD WALL
RAL1034



WOOD WALL
RAL9010

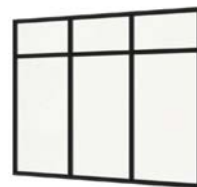

GLASS WALL
RAL9005



GLASS SLIDING DOOR
RAL9005



RELAXING IN PRIVACY GUARANTEED!

Going outside is an ideal way to treat yourself to a well-deserved break from time to time. Stress is almost a daily occurrence these days, no matter whether you are young or old. Therefore, it is not surprising that after a long day you feel the need to be able to relax for a while.

After work or in the weekends, we are more than happy to trade the couch in the living room for a garden summer paradise. After all, the 'four garden walls' at home are perfect for the quest of relaxation and recreation. In this respect, the right accessories ensure that you also get the privacy you need in the garden. With our privacy fences and trellises, it is possible to relax in the seclusion of your own garden.

And this can be achieved in a personalized way, entirely to the taste of every garden lover. Secret nooks where you can enjoy moments of peace and quiet. Well-deserved privacy after a long day, to be enjoyed alone or with the whole family. Visual accents created as different flowers and plants grow around the trellis.

We have great ideas! Just browse through the following pages and find out for yourself.





NEW

MODULAR CONCRETE POSTS

Offer your customers a new type of fence to delineate and shield their garden – a combination of concrete and wood. Not only is this new product very low-maintenance and durable, but it also is a visual highlight for any garden. Due to the properties of concrete, this modular system offers many benefits and enables a versatile customization of the product in terms of layout and look.

Concrete posts anthracite, visible quality, steel reinforced.

Specially manufactured smooth surfaces.

Accessories: set of 6 L-brackets (incl. 3 connecting bolts with socket).



Art.-Nr.	W x D x H in cm	Indication	VE
1911200200	10 x 10 x 280	Concrete posts, link post	20
1911010278	10 x 10 x 280	Concrete posts, end post	20
1931010278	10 x 10 x 280	Concrete posts, corner post	20
1941010278	10 x 10 x 280	Concrete posts, T-post	20
1911842536	184 x 26 x 3,7	Guard beam	30
0000000333		L-Winkel 6er-Set	20 x 6



DURABLE



LOW MAINTENANCE



STRONG



POSTS OVERVIEW

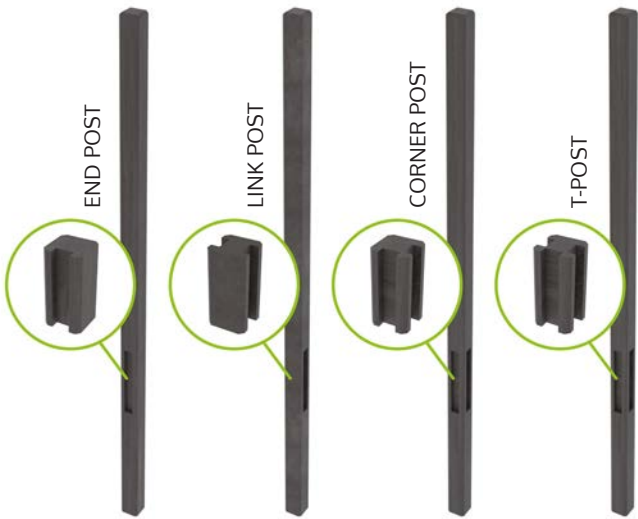

ADVANTAGES

- Can be combined with commercially available fences: wood, WPC, aluminum, etc.
- Weatherproof and easy to maintain
- Concrete anthracite color, visible quality, with steel reinforcement
- Smooth surface
- Parts can be optionally painted with concrete color
- Splash guard beam protects against moisture from the ground and damage from e.g. a lawn trimmer
- Fences can easily be replaced later

ASSEMBLY

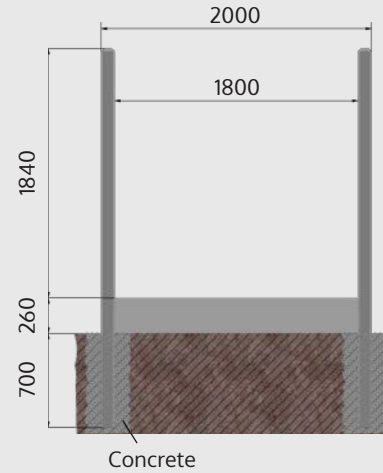
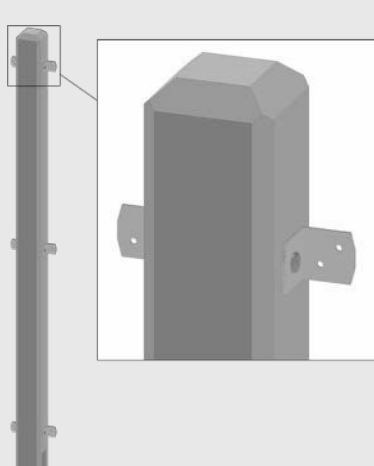
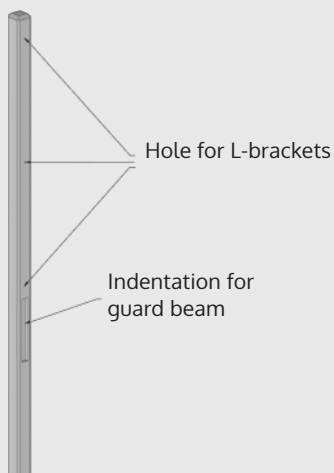



NEW

LARCH



ZAUN MULTI

Larch boards 10 x 95 mm, untreated, crossbeams made of pine wood, 15 x 68 mm, anthracite stained.

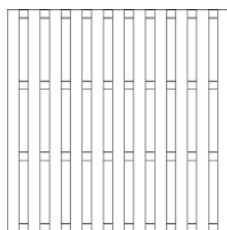

W x D x H in cm	180 x 180
Art.-Nr.	8022951818
VE	34

POSTS:
Suitable post scan be found on pages 54/55.



RHOMBUS FENCE KLARA LARCH

Rhombus battens 22 x 70 mm, vertical crossbeams 22 x 70 mm, untreated larch.



W x D x H in cm	180 x 180	90 x 180
Art.-Nr.	8022601818	8022609018
VE	24	12

MAINTENANCE TIP FOR LARCH WOOD:

To maintain the warm, reddish color of the wood, we recommend painting with an open-pored, pigmented stain. Please note that the natural elements will turn grey due to weathering.





LARCH



FENCE LOLLAND LARCH

Boards 13 x 135 mm, 3 ledgers 16 x 68 mm, untreated larch, attached with stainless steel nails.

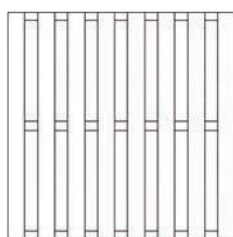

W x D x H in cm

180 x 180

Art.-Nr.

0816131818

VE

28

POSTS:

Suitable post can be found on pages 54/55.



LARCH

PICKET FENCE HONO LARCH

17 battens 30 x 50 mm, beveled head, crossbars 30 x 50/40 mm, untreated larch, attached with stainless steel nails.

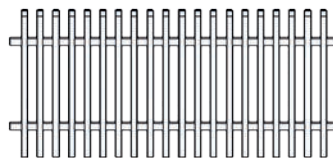

B x T x H in cm

180 x 80

Art.-Nr.

1319901880

VE

20

MAINTENANCE TIP FOR LARCH WOOD:

To maintain the warm, reddish color of the wood, we recommend painting with an open-pored, pigmented stain. Please note that the natural elements will turn grey due to weathering.





VINTAGE-GREY OFFERING



FENCE LOLLAND VINTAGE

Boards 13 x 135 mm, 3 ledgers 16 x 68 mm, pine, gray pressure impregnated, attached with stainless steel nails.

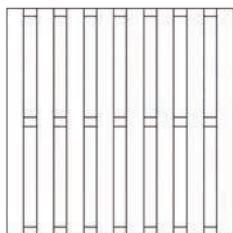

W x D x H in cm

180 x 180

Art.-Nr. grey impreg.

0815131818

VE

28

POSTS:

Suitable post can be found on pages 54/55.

VINTAGE-GREY OFFERING



CLOSED FENCE RANGER VINTAGE

Boards 16 x 110-160 mm, rough sawn, ledgers 30 x 60 mm, gray pressure impregnated, attached with stainless steel nails.

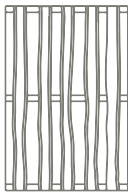
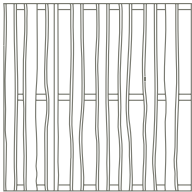

W x H in cm	180 x 180	120 x 180	90 x 180
Art.-Nr. grey impreg.	0816011818	0816011218	0816019018
VE	19	12	12



NEW



Rhombus fence larch tone impregnated



Rhombus fence larch wood

RHOMBUS FENCE

Rhombus battens 22 x 70 mm, vertical crossbeams 22 x 70 mm, optionally untreated larch or larch tone pressure impregnated.



W x D x H in cm	180 x 180	90 x 180
Art.-Nr. Larch	8022601818	8022609018
Art.-Nr. larch tone impreg.	0722701818	0722709018
VE	24	12

MAINTENANCE TIP FOR LARCH WOOD:

To maintain the warm, reddish color of the wood, we recommend painting with an open-pored, pigmented stain. Please note that the natural elements will turn grey due to weathering.

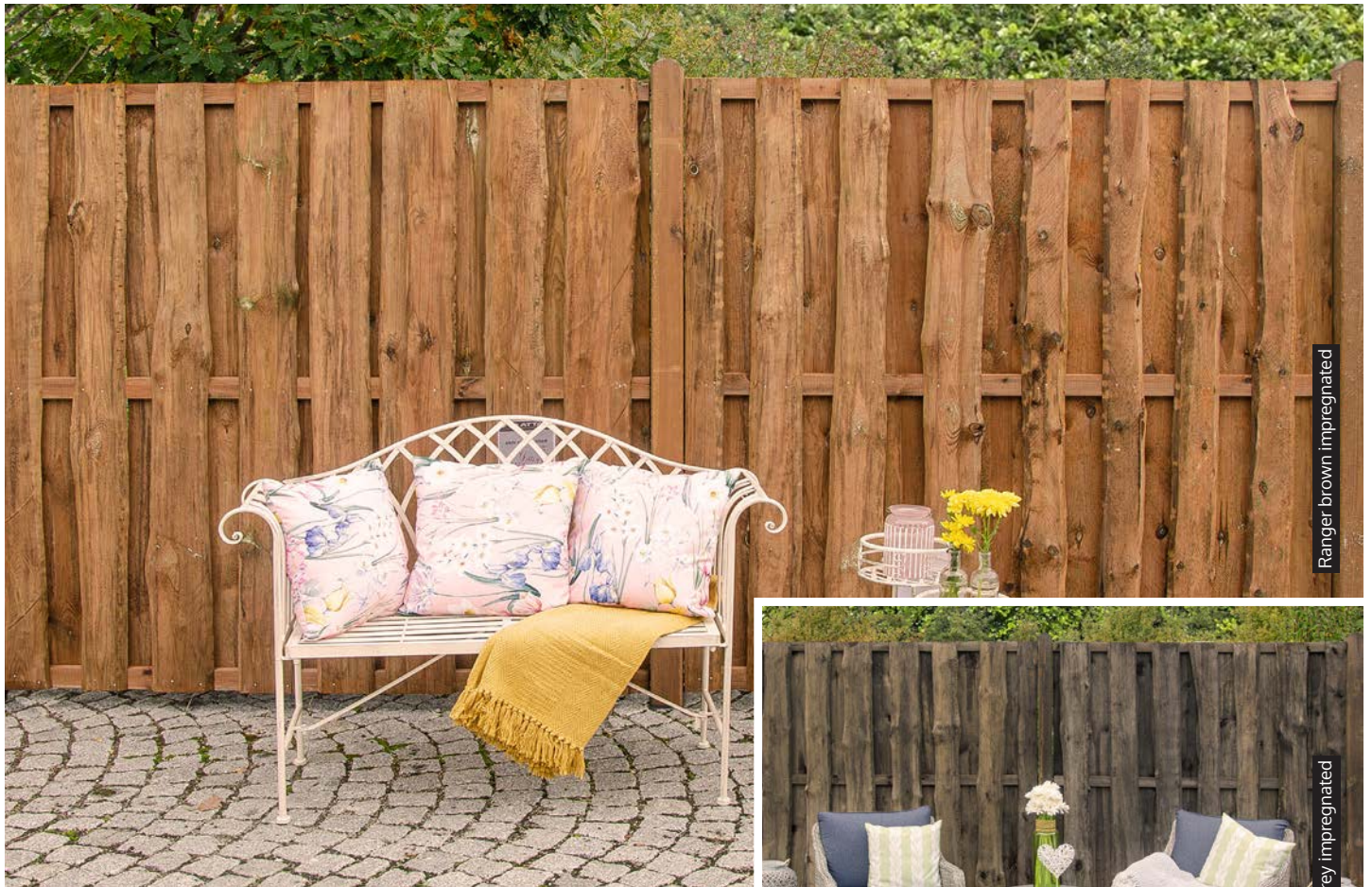

Ranger brown impregnated



Ranger grey impregnated

CLOSED FENCE RANGER

Boards 16 x 110-160 mm, rough sawn, ledgers 30 x 60 mm, vintage-grey pressure impregnated or brown pressure impregnated, attached with stainless steel nails.

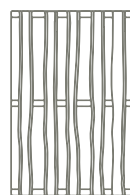
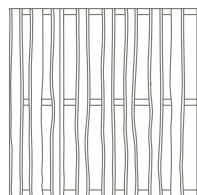

W x H in cm	180 x 180	120 x 180	90 x 180
Art.-Nr. brown impreg.	0816111818	0816111218	0816119018
Art.-Nr. vintage-grey impreg.	0816011818	0816011218	0816019018
VE	19	12	12

POSTS:

Suitable post can be found on pages 54/55.





Till pine stained



Till green impregnated

FENCE SERIES TILL

Frame 40 x 65 mm, slats 8 x 95 mm, profiled, battens 12 x 28 mm, pine, optionally stained or green pressure impregnated, slats attached with stainless steel screws.



W x H in cm	180 x 180	90 x 180	90 x 180/90
Art.-Nr. green impreg.	0219461818	0219469018	0219469890
Art.-Nr. pine stained	9046181811	9046901811	9046989011
VE	28	14	14

MAINTENANCE TIP:

Our colored fences are pre-treated. Maintenance instructions and information on color-treated products can be found on page 68.

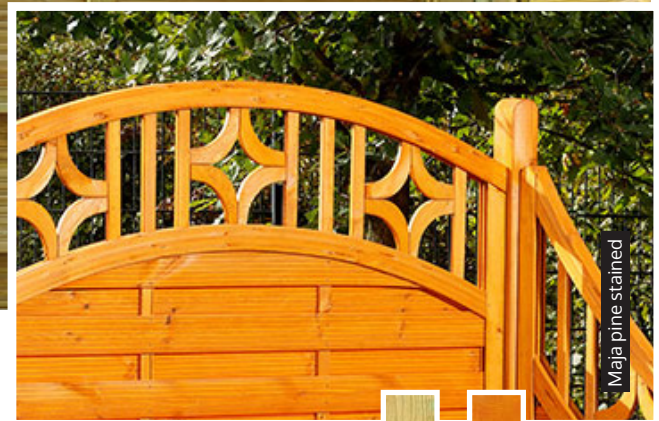

FENCE SERIES MAJA

Frame 42 x 65 mm, slats 8 x 95 mm, grooved, pine, optionally stained or green pressure impregnated, slats attached with stainless steel screws.



W x H in cm	180 x 180	90 x 180	90 x 180/90
Art.-Nr. green impreg.	0613631818	0613639018	1513069018
Art.-Nr. pine stained	0216851818	0216859018	0216901890
VE	24	12	12



W x H in cm	180 x 90	180 x 180/160	90 x 180/160
Art.-Nr. green impreg.	1206181890	0625631818	0625639018
Art.-Nr. pine stained	0216851890	0216851816	-
VE	24	24	12

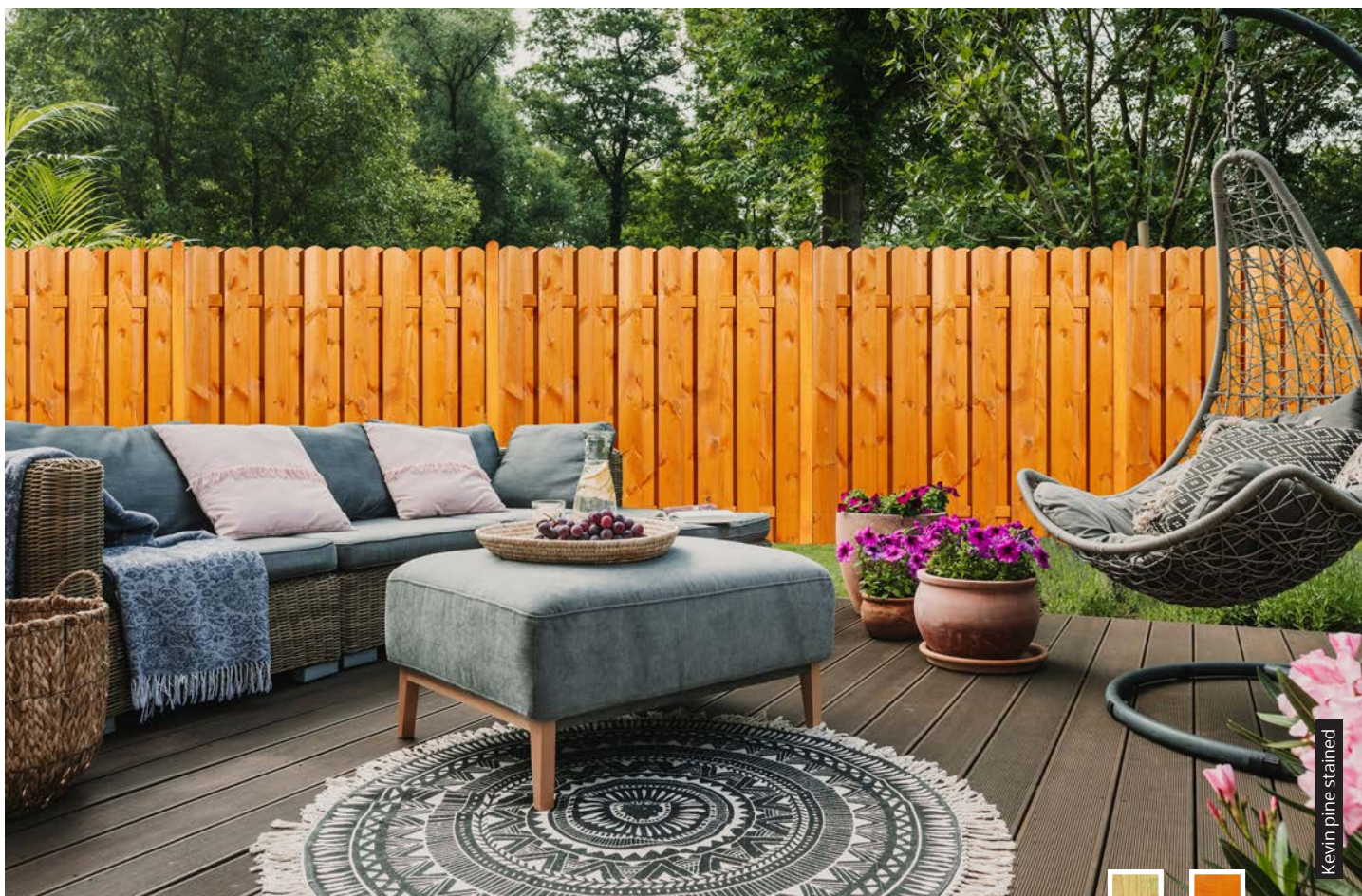

CLOSED FENCE KEVIN

Boards 16 x 145 mm, rounded and chamfered head, 2 ledgers 30 x 70 mm, chamfered, pine, optionally stained or green pressure impregnated, stainless steel joints.



W x H in cm	180 x 180	180 x 180/160	90 x 172/90
Art.-Nr. green impreg.	0894161818	0894161816	1508949017
Art.-Nr. pine stained	0895161818	0895161816	9089901711
VE	19	19	12

MAINTENANCE TIP:

Our colored fences are pre-treated. Maintenance instructions and information on color-treated products can be found on page 68.

CLOSED GATE KEVIN

Boards 16 x 145 mm, rounded and chamfered head, 2 ledgers 30 x 70 mm, chamfered, pine, optionally stained or green pressure impregnated, stainless steel joints, without fittings.

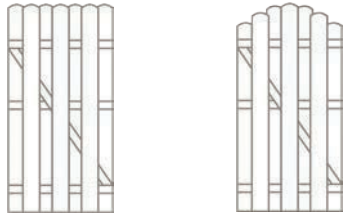

W x H in cm	90 x 180	90 x 180/160
Art.-Nr. green impreg.	1489490180	1489490186
Art.-Nr. pine stained	9094901811	9094908611
VE	5	5



FENCE STACH

Battens 14 x 70 mm, vertical ledgers 22 x 70 mm, basalt gray 2-layer stained, stainless steel stapled strips.



W x H in cm	180 x 180
Art.-Nr.	9022181812
VE	30



POSTS:

Suitable post can be found on pages 54/55.





NEW

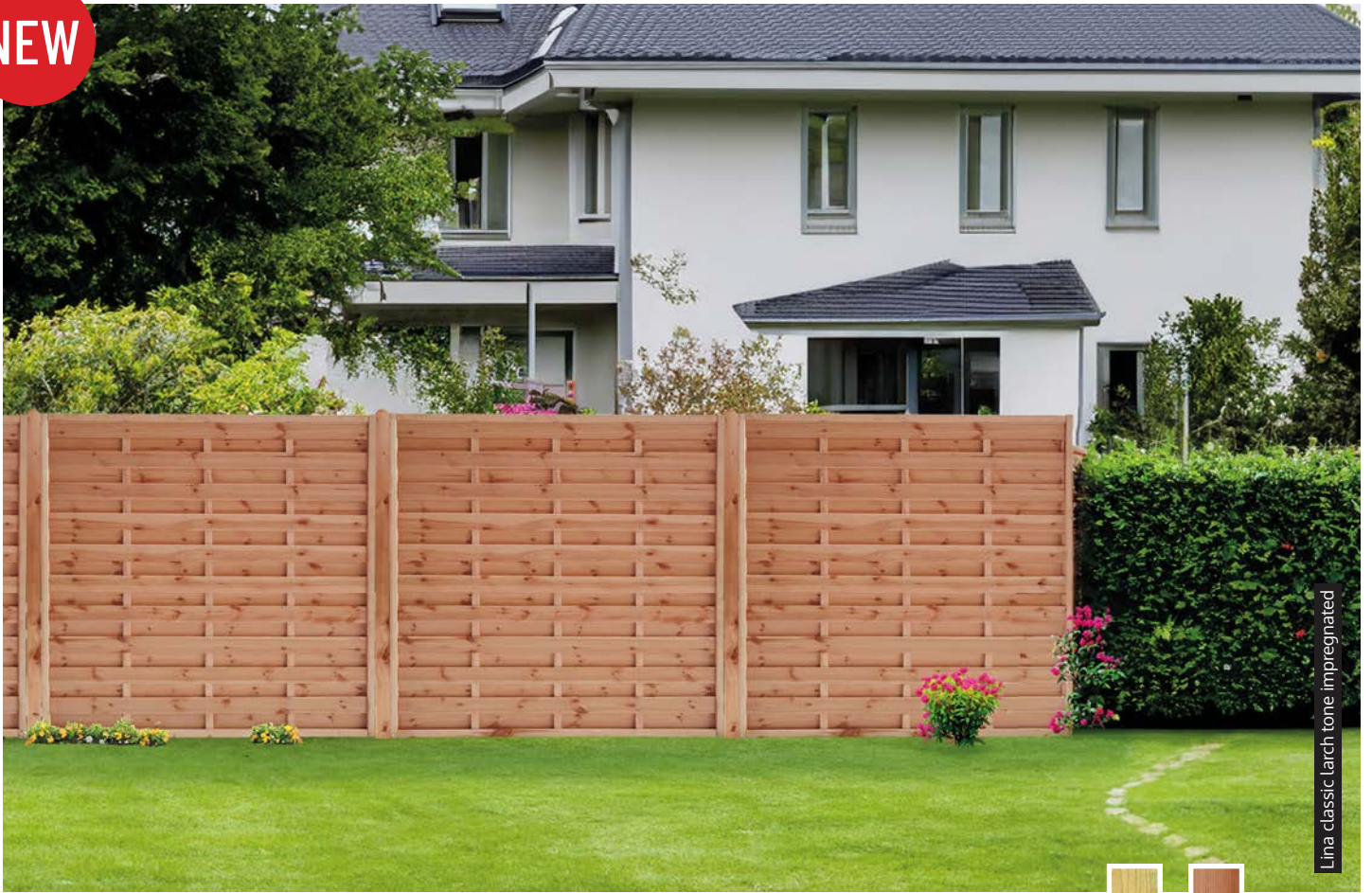

FENCE SERIES LINA CLASSIC

Frame 42 x 42 mm, battens 8 x 95 mm, grooved, pine, green pressure impregnated or larch tone impregnated, battens attached with stainless steel screws.



W x H in cm	180 x 180	150 x 180	100 x 180
Art.-Nr. green impreg.	0219441818	0219441518	0219441018
Art.-Nr. larch tone impreg.	0218441818	-	0218441018
VE	24	24	24/12



W x H in cm	90 x 180/90	180 x 150
Art.-Nr. green impreg.	1519029018	0219441815
VE	12	24

SERIES LINA CLASSIC

Frame 42 x 42 mm, battens 8 x 95 mm, grooved, pine, green pressure impregnated or larch tone impregnated, battens attached with stainless steel screws.

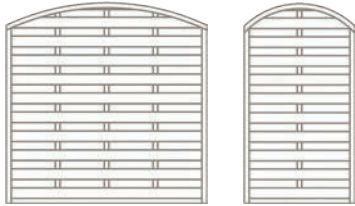

W x H in cm	180 x 180/160	100 x 180/160
Art.-Nr. green impreg.	0229441816	0229441018
VE	24	12



GATE LINA CLASSIC

Suitable for all fence gates with battens 8 x 95 mm, grooved, frame 44 x 90 mm, smooth planed, green pressure impregnated, without fittings.



W x H in cm	100 x 180
Art.-Nr. green impreg.	1414901018
VE	5



POSTS:

Suitable post can be found on pages 54/55.



FENCE SERIES OLGA

Frame 42 x 42 mm, battens 9 x 90 mm, profiled, top: fine-sawn battens 12 x 28 mm, pine, green pressure impregnated, battens attached with stainless steel screws.



W x H in cm	180 x 180	90 x 180
Art.-Nr. green impreg.	0669421818	0669429018
VE	24	24



W x H in cm	90 x 180/120	180 x 120
Art.-Nr. green impreg.	0642901812	0669421812
VE	24	24



TRELLIS KINGA

Battens 12 x 28 mm, planed, chamfered, batten spacing approx. 145 mm, pine, green pressure impregnated, galvanized brackets.



W x H x H in cm	38 x 180	55 x 180
Art.-Nr. green impreg.	1118003818	1118005518
VE	64	64



SHOWS A LOT- BUT NOT EVERYTHING! FRONT YARD FENCES

A personalized front yard is to some extent a reflection of the character of the people or families who live behind it. The design of the front yard shows how much people love their garden. The front yard is the signature of a home, a welcoming sight with plants and flowers. And that at any time of the year! Whether it is the first flowers that signal the beginning of spring, the beautiful greenery of summer, the colorful leafy accents of fall, or the fairy lights that create a Christmas atmosphere. Every season a different surprise hides behind the front yard fence. Our front yard fences capture the magic of beautifully designed garden life...

However, fences should not detract from lovingly designed gardens. They should blend naturally into their surroundings.

They are meant to frame the beauty of your garden!

Create the perfect frame for your own property, arousing curiosity about the garden paradise beyond! Give passersby a glimpse of your personalized front yard and, depending on the season, let the corresponding designs shine through the fence. Welcome your guests to your home and make them feel at home with every visit!







FENCE LENI

NEW

Frame 40 x 60 mm, battens 10 x 40 mm, boards 10 x 110 mm, larch tone pressure impregnated.



W x H in cm	180 x 90
Art.-Nr. larch tone impreg.	0217341890
VE	24

MINI-PICKET FENCE

Stakes 16 x 55 mm, with rounded head. The two outer ones are 60 cm long with point for hammering into the ground, otherwise 30 cm, pine, green pressure impregnated.



W x H in cm	120 x 30/60
Art.-Nr. green impreg.	1445141230
VE	40

MAINTENANCE TIP:

Our colored fences are pre-treated. Maintenance instructions and information on color-treated products can be found on page 68.

PICKET FENCE EMMA

15 battens 27 x 70 mm, with rounded head, 2 ledgers 25 x 70 mm, pine, optionally stained or green pressure impregnated, attached with stainless steel nails.

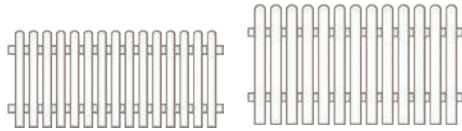

W x H in cm	180 x 80	180 x 100
Art.-Nr. green impreg.	1327701880	1327701810
VE green impreg.	20	20
Art.-Nr. pine stained	9027708011	9027701011
VE pine stained	10	10



PICKET FENCE GATE EMMA

Battens 27 x 70 mm, with rounded head, 2 ledgers 25 x 70 mm, pine, optionally stained or green pressure impregnated, attached with stainless steel nails, without fittings.



W x H in cm	100 x 80	100 x 100
Art.-Nr. green impreg.	1427701080	1427701010
VE green impreg.	10	10
Art.-Nr. pine stained	9027108011	9027101011
VE pine stained	5	5



POSTS:

Suitable post can be found on pages 54/55.





Niklas pine stained

PICKET FENCE NIKLAS

13 battens 19 x 90 mm, with rounded and chamfered head, 2 ledgers 22 x 70 mm, pine, optionally stained or green pressure impregnated, attached with stainless steel nails.

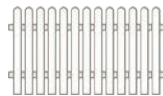
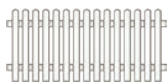

W x H in cm	180 x 85	180 x 100	180 x 71/85
Art.-Nr. green impreg.	1319901885	1319901810	1319187185
VE green impreg.	20	20	20
Art.-Nr. pine stained	9019901885	9019901011	9019908711
VE pine stained	20	10	10

MAINTENANCE TIP:

Our colored fences are pre-treated. Maintenance instructions and information on color-treated products can be found on page 68.

POSTS:

Suitable post can be found on pages 54/55.

PICKET FENCE BATTENS NIKLAS

19 x 90 mm, smooth planed, with rounded head, pine, green pressure impregnated.



W x H in cm	1,9 x 9 x 85	1,9 x 9 x 100
Art.-Nr. green impreg.	4311199085	4311199100
VE	200	200

PICKET FENCE BEAMS NIKLAS

22 x 70 mm, smooth planed, pine, green pressure impregnated.



W x H in cm	2,2 x 7 x 180
Art.-Nr. green impreg.	3098227018
VE	50

PICKET FENCE GATE NIKLAS

Battens 19 x 90 mm, with rounded and chamfered head, ledgers 22 x 70 mm, pine, optionally stained or green pressure impregnated, attached with stainless steel nails, without fittings.

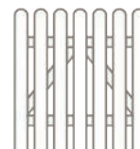

W x H in cm	100 x 85	1,9 x 9 x 100
Art.-Nr. green impreg.	1496191085	1496191010
VE green impreg.	5	5
Art.-Nr. pine stained	9019901085	9096191111
VE pine stained	5	5



VERTICAL STRAIGHT FENCE

Milled half-rounded battens with cone, thickness approx. 60 mm, 21 battens/field, 2 ledgers Ø 70 mm, galvanized nails attached to the front, pine, brown pressure impregnated.



W x H in cm	250 x 80	250 x 100
Art.-Nr. brown impreg.	1889602580	1889602510
VE brown impreg.	20	20

VERTICAL STRAIGHT FENCE GATE

Single door, straight, milled half-rounded battens with cone, thickness approx. 60 mm, side frames 27 x 120 mm, galvanized nails attached to the front, pine, brown pressure impregnated, without fittings.



W x H in cm	100 x 80	100 x 100
Art.-Nr. brown impreg.	1489181080	1489181010
VE brown impreg.	10	10



BOARD FENCE

Unedged, 2,4 cm thick, 15 to 25 cm wide, rough sawn, pine, brown pressure impregnated.

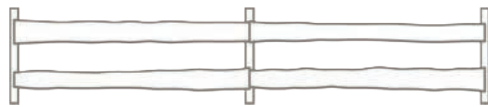

W x H in cm	15-25 x 2,4 x 250
Art.-Nr. brown impreg.	0015252425
VE brown impreg.	50

INFO:

Individual battens and fence beams can be found on page 39..



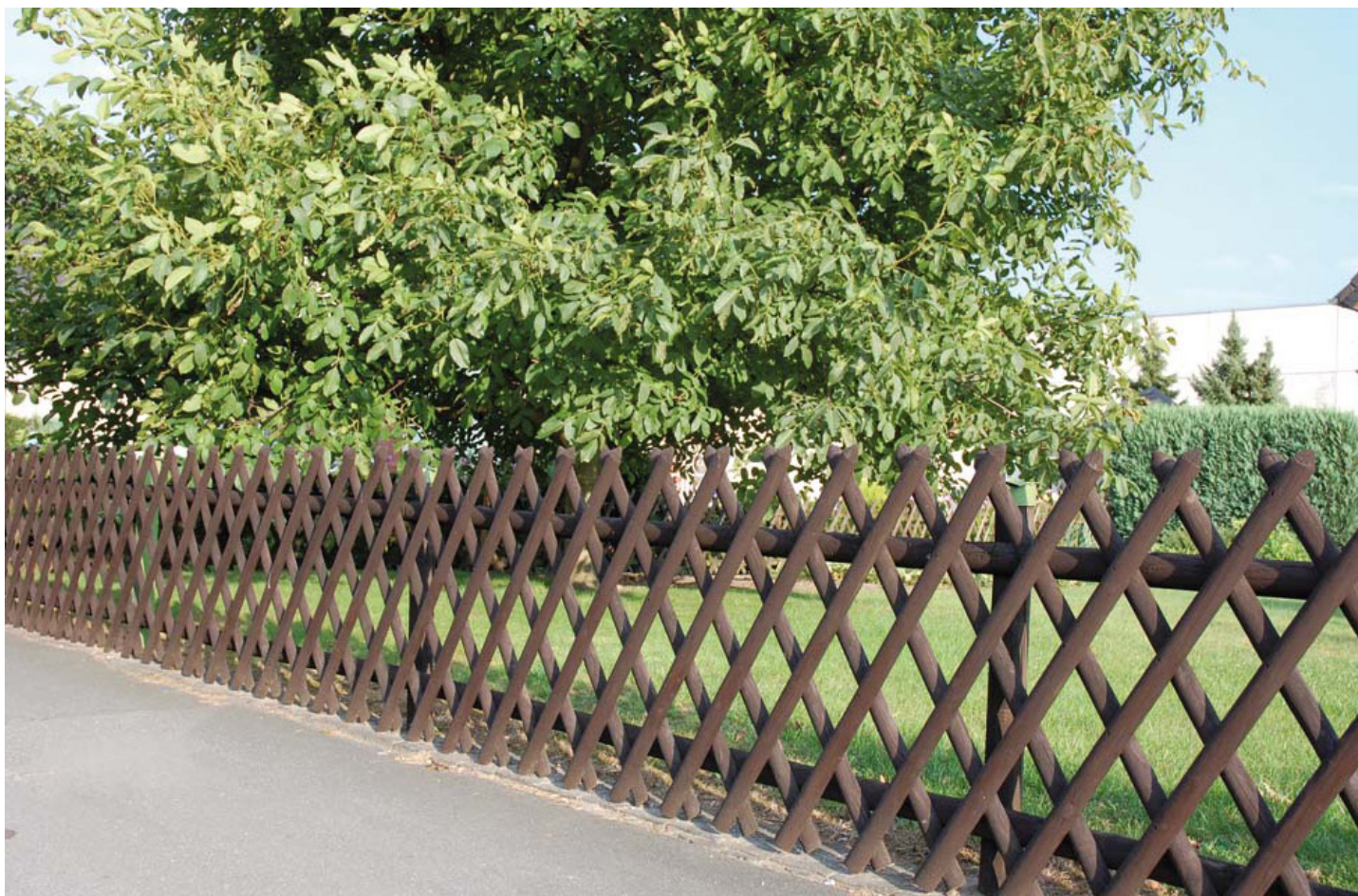

HUNTER FENCE

Milled half-rounded battens with cone, 22 battens/field, batten thickness 46 mm or 55 mm, galvanized nails, pine, brown pressure impregnated.

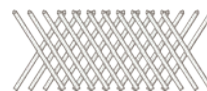

Ø Battens	4,6	5,5	5,5
W x H in cm	250 x 60	250 x 80	250 x 100
Art.-Nr. brown impreg.	1888462560	1789552580	1789552510
VE brown impreg.	40	40	40

HUNTER FENCE GATE

Single door, straight, milled half-rounded battens with cone, side frames 27 x 120 mm, batten thickness 46 mm or 55 mm, galvanized nails, pine, brown pressure impregnated, without fittings.



Ø Battens	4,6	5,5	5,5
W x H in cm	100 x 60	100 x 80	100 x 100
Art.-Nr. brown impreg.	1489461060	1489171080	1489171010
VE brown impreg.	10	10	10

INDIVIDUAL BATTENS

Milled, separated in the middle, head with cone, pine, brown pressure impregnated.

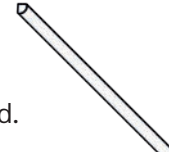

Ø x L in cm	5,5 x 80	5,5 x 100	5,5 x 120
Art.-Nr. brown impreg.	3898005580	3898005510	3898005512
VE brown impreg.	100	100	100

FENCE BEAMS

Evenly milled round, separated in the middle, chamfered on 2 sides, pine, brown pressure impregnated.

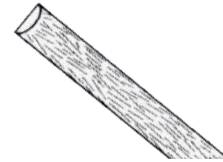

Ø x L in cm	7 x 200	7 x 250	8 x 250
Art.-Nr. brown impreg.	3098100720	3098000725	3098000825
VE brown impreg.	80	80	80

FENCE POSTS

Round milled, with point, chamfered head, pine, brown pressure impregnated.



Ø x L in cm	7 x 125	7 x 150	8 x 125	8 x 150	8 x 175
Art.-Nr. brown impreg.	2789007125	2789007150	2789008125	2789008150	2789008175
VE brown impreg.	144	144	98	98	98



PLAYGROUND EQUIPMENT

Children are the most precious thing we have! After all, they are our future! To give the little ones the best possible start, it is important to provide them with a carefree childhood. Spending time outdoors plays an important role in this.

Exploring nature together with their friends! Romping around in the garden! That makes a children's heart beat faster! To ensure that grownups do not have to worry, the best place to carry this out is the personal garden. With our playground equipment the adventure land of the children will become complete. Our playground equipment offers the necessary fun factor for the smallest among us.

We guarantee stability and safety! In this way, the little ones can play carefree, while the adults can relax worry-free.







NEW



Theo larch tone impregnated



SWING THEO

Double timber swing Theo, crossbar 9 x 9 x 300 cm, 4 beams 9 x 9 x 240 cm, green pressure impregnated or larch tone impregnated, TÜV-tested.

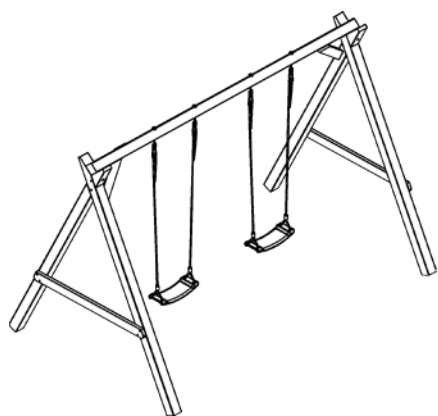

W x H in cm	306 x 220 x 220
Art.-Nr. green impreg.	4622003000
Art.-Nr. larch tone impreg.	4622003013
VE	8

NEW



CLIMBING SWING EMIL

Double timber swing Emil with ladder and platform, as well as climbing rope, crossbar 9 x 9 x 323 cm, 6 beams 9 x 9 x 240 cm, green pressure impregnated or larch tone impregnated, optional slide (not included), TÜV-tested.



für Kinder
3-14



W x H in cm 385 x 220 x 220

Art.-Nr. green impreg. 4622003820

Art.-Nr. larch tone impreg. 4622003813

VE 6





NEW



Mika larch tone impregnated



CLIMBING SWING MIKA

Double timber swing with ladder and platform, crossbeam 10 x 300 cm, 6 round beams 8 x 250 cm, Dubbele houten schommel met ladder en platform, dwarsbalk 10 x 300 cm, 6 ronde balken 8 x 250 cm, green pressure impregnated or larch tone impregnated, optional slide (not included), TÜV-tested.



W x H in cm	300 x 220 x 222
Art.-Nr. green impreg.	4622003600
Art.-Nr. larch tone impreg.	4622003613
VE	6

NEW



CLIMBING SWING BRUNO

Double roundwood swing with ladder and platform, as well as rope ladder, crossbar 10 x 360 cm, 6 round beams 10 x 250 cm, green pressure impregnated or larch tone impregnated, optional slide (not included), TÜV-tested.



für Kinder
3-14



B x H in cm 406 x 220 x 222

Art.-Nr. green impreg. 4619004160

Art.-Nr. larch tone impreg. 4619004113

VE 4





NEW



CLIMBING SWING MALIK

Double roundwood swing with ladder and platform, as well as rope ladder, crossbar 14 x 400 cm, 6 round beams 12 x 300 cm, green pressure impregnated or larch tone impregnated, optional slide (not included), TÜV-tested.



W x H in cm	470 x 180 x 237
Art.-Nr. green impreg.	4618304700
Art.-Nr. larch tone impreg.	4618304713
VE	4

NEW



Toni green impregnated with add-on swing



CLIMBING TOWER TONI

Climbing tower, made of squared beams 7 x 7 cm, sandbox boards 28 mm, incl. ladder, roof made of boards 21 mm, green pressure impregnated or larch tone impregnated, optional slide (not included), TÜV-tested.

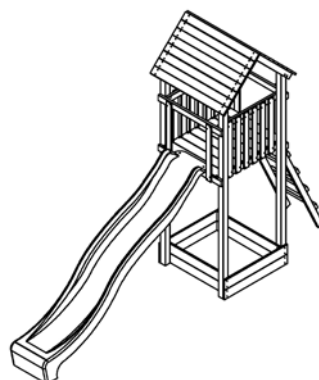

Tower



Add-on swing (dimensions incl. tower)



W x H in cm	90 x 94 x 288	336 x 216 x 288
Art.-Nr. green impreg.	4615900940	4621583358
Art.-Nr. larch tone impreg.	4615900913	4621583313
VE	5	5





SWING POLDI

Single roundwood swing, crossbar 10 x 150 cm, round beams 8 x 240 cm, green pressure impregnated.



für Kinder
3-14



W x H in cm	230 x 220 x 225
Art.-Nr. green impreg.	4523220225
VE	6

SANDBOX DEVIN

Sandbox Devin, 16 mm boards, green pressure impregnated.



für Kinder
1-14

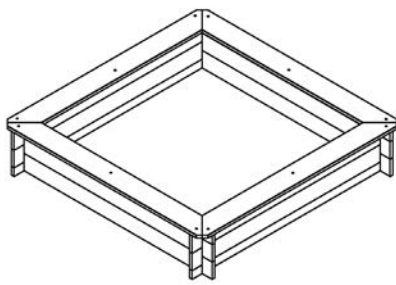

W x H in cm	120 x 120 x 25
Art.-Nr. green impreg.	0012012025
VE	8

SANDBOX HANNA

Building kit made of planed boards 22 c 90 mm, corner posts 9 x 9 cm, seat made of boards 28 x 145 mm, incl. assembly material, green pressure impregnated.

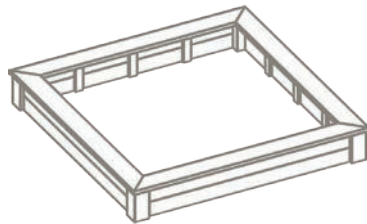

W x H in cm	150 x 150 x 20	180 x 180 x 20
Art.-Nr. green impreg.	0000151530	0000181830
VE	4	4



SANDBOX LID HANNA

2-pieces, made of planed boards 22 x 90 mm, green pressure impregnated.



W x H in cm	150 x 150 x 5	180 x 180 x 5
Art.-Nr. green impreg.	0000015155	0000018185
VE	4	4





FENCE POSTS CONSTRUCTION TIMBER DECKING BOARDS ANCHORS & FITTINGS

Turning your green space at home into a paradise all by yourself is probably the goal of every garden lover. After all, the more work you put into something, the more enjoyment you get out of it. However, it is not only the homeowners who benefit from the beauty of the garden they have created.

Homeowners are just as proud to present their garden to their guests. In that case, the art is in the details. In the end, a harmonious picture emerges from the many individual pieces. By offering the right components the inner architect in every garden lover is awakened. Our decking boards and construction timber are the ideal elements for the creation of a personal project.

Of course, these creations should last a long time. It goes without saying that high-quality resources are a must for us.







CONSTRUCTION TIMBER SMOOTH

Pine, clean-planed, green pressure impregnated.

Dimensions in cm	Art.-Nr.	VE
2,1 x 9 x 300	3522219030	180
2,1 x 9 x 400	3522219040	180
2,1 x 12 x 300	3522211230	135
2,1 x 12 x 400	3522211240	135
2,1 x 14,5 x 300	3522114530	105
2,1 x 14,5 x 400	3522114540	105
2,8 x 14,5 x 300	3522814530	84
2,8 x 14,5 x 400	3522814540	84
4,5 x 7 x 300	3528457030	105
4,5 x 7 x 400	3528457040	105
4,5 x 9 x 300	3529459030	30
4,5 x 9 x 400	3529459040	30
4,5 x 14,5 x 300	3528451453	49
4,5 x 14,5 x 400	3528451454	49
6 x 12 x 300	3528601230	72
6 x 12 x 400	3528601240	72



CONSTRUCTION TIMBER SMOOTH/RIBBED

Pine, smooth on one side, ribbed on the other, green pressure impregnated.

Dimensions in cm	Art.-Nr.	VE
2,1 x 9 x 300	3622190300	180
2,1 x 9 x 400	3622190400	180
2,1 x 14,5 x 300	3622145300	105
2,1 x 14,5 x 400	3622145400	105
2,8 x 14,5 x 300	3689281453	84
2,8 x 14,5 x 400	3689281454	84

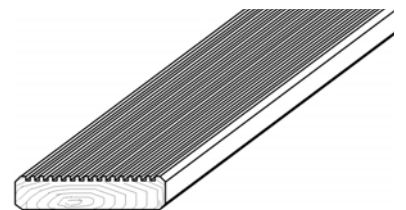

DECKING BOARDS GROOVED/FLUTED

Pine, grooved on one side, ribbed on the other, green pressure impregnated.

Dimensions in cm	Art.-Nr.	VE
2,8 x 14,5 x 300	3602814530	84
2,8 x 14,5 x 400	3602814540	84



GARDEN TILES

Pine, chamfered edges, galvanized brackets, green pressure impregnated.



W x H in cm	50 x 50 x 2,8
Art.-Nr.	2110144055
Planed	Ribbed 7 top batten: 14 x 60 mm 3 bottom batten: 14 x 27 mm
VE	80

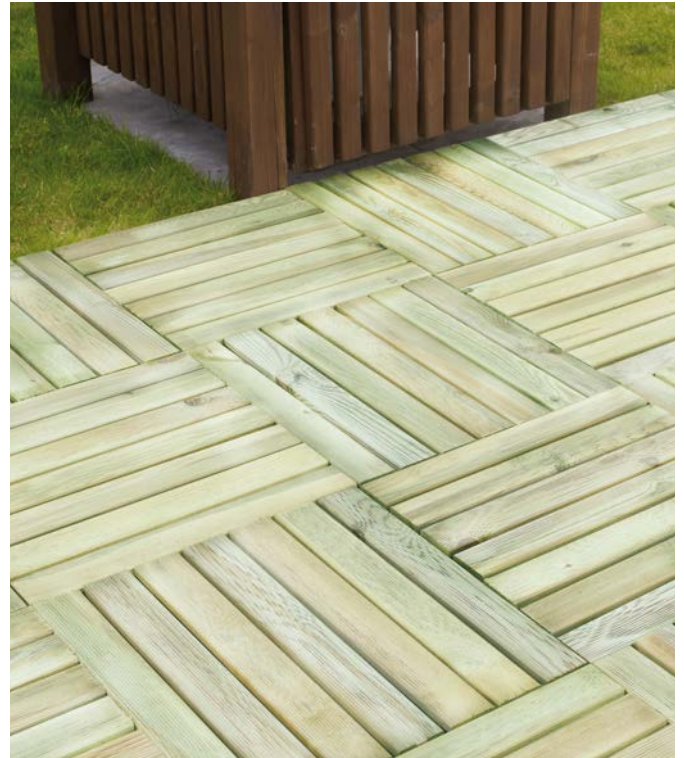



FENCE POSTS STRAIGHT CUT

Quarter sawn, pine, straight cut on both sides, clean-planed with rounded edges, green pressure impregnated.



Dimensions in cm	Art.-Nr.	VE
7 x 7 x 180	3228777718	48
7 x 7 x 210	3228007721	48
7 x 7 x 240	3228007724	48
7 x 7 x 270	3228007727	48
7 x 7 x 300	3228007730	48

Dimensions in cm	Art.-Nr.	VE
9 x 9 x 180	3228999918	55
9 x 9 x 210	3228009921	55
9 x 9 x 240	3228009924	55
9 x 9 x 270	3228009927	55
9 x 9 x 300	3228009930	55

FENCE POSTS LARCH STRAIGHT CUT

Larch, untreated, straight cut, clean-planed.



Dimensions in cm	Art.-Nr.	VE
9 x 9 x 90	8032299900	55
9 x 9 x 180	8032299180	55

FENCE POSTS ROUNDED HEAD

Quarter sawn, pine, rounded head, clean-planed with rounded edges.

GREEN IMPREGNATED

Dimensions in cm	Art.-Nr.	VE
9 x 9 x 95	3498099095	55
9 x 9 x 110	3499019911	55
9 x 9 x 120	3294909012	55
9 x 9 x 150	3294909015	55
9 x 9 x 190	3194909019	55



BROWN IMPREGNATED

Dimensions in cm	Art.-Nr.	VE
9 x 9 x 190	3227639919	55



VINTAGE-GREY IMPREGNATED

Dimensions in cm	Art.-Nr.	VE
9 x 9 x 190	3195909019	55



LARCH TONE IMPREGNATED

Dimensions in cm	Art.-Nr.	VE
9 x 9 x 95	3294899995	55
9 x 9 x 190	3184909019	55



PINE COLOR STAINED

Dimensions in cm	Art.-Nr.	VE
9 x 9 x 100	9034991011	55
9 x 9 x 190	9034991911	55



ANTHRACITE STAINED

Dimensions in cm	Art.-Nr.	VE
7 x 7 x 190	9037719012	24



BASALT GREY 2-LAYER-STAINED

Dimensions in cm	Art.-Nr.	VE
9 x 9 x 190	9034991912	55



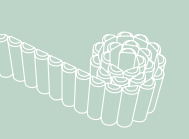

PERGOLAS POSTS, PALISADES, PLANTERS & MORE

A flower bed is probably one of the most essential elements of a garden and should therefore not be absent. That is, a sea of flowers provides both aesthetical appeal and pleasant fragrances that caress the nose. What better way to frame the flower beds than with wood?! Whether in the center of the garden paradise or as ornaments along the path. Wood palisades offer the ideal way to frame flower arrangements and make them visually striking.

A high degree of stability is guaranteed, which means that the flower beds can also be placed on small hills without hesitation. Curved arrangements can also be created without problems by using roll boards made of small semicircular posts. Our palisades, posts, and roll boards provide the ideal support for various homemade creations. In this way, every garden lover can make his or her own green paradise. And that with top quality for affordable prices!





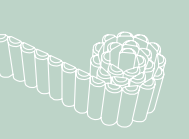

MINIPALISADEN

Evenly round milled, chamfered on one size, pointed on the other, pine, green pressure impregnated.



Ø x L in cm	6 x 30
Art.-Nr. green impreg.	2788000630
VE	500



ROLLBOARDS

Evenly milled half-round palisades, chamfered on one size, stapled on galvanized wire, pine, green pressure impregnated.

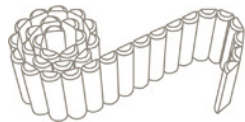

W x H in cm	6 x 20 x 200	6 x 30 x 200
Art.-Nr.	2698462020	2698630200
VE	48	36



TREE POSTS

Evenly round milled, chamfered on one side, pointed on the other, pine, green pressure impregnated.



Ø x L in cm	Art.-Nr.	VE
4,6 x 100	2788046100	200
4,6 x 125	2788046125	200
4,6 x 150	2788046150	200
6 x 100	2788006100	100
6 x 125	2788006125	100
6 x 150	2788006150	100
6 x 175	2788006175	100
6 x 200	2788006200	100
7 x 100	2788007100	105
7 x 150	2788007150	105
7 x 200	2788007200	105
7 x 250	2788007250	105
8 x 100	2788008100	98
8 x 125	2788008125	98
8 x 150	2788008150	98
8 x 200	2788008200	98
8 x 250	2788008250	98
10 x 100	2788010100	66
10 x 150	2788010150	66
10 x 175	2788010175	66
10 x 200	2788010200	66



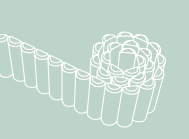

PERGOLA FREIBURG

4 posts 7 x 7 x 210 cm, 2 glued arches 3,5 x 7 x 157 cm, 5 crossbars 3,5 x 7 x 68 cm, 2 trellises 40 x 160 cm, trellis frames 10 x 18 mm, passage approx. 120 cm, pine, green pressure impregnated.

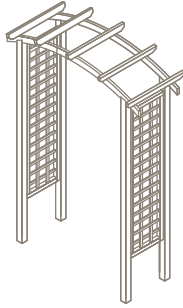

W x H x D in cm	68 x 157 x 210
Art.-Nr.	2412000000
VE	6

RAISED BED FROM RHOMBUS BATTENS

Raised bed, pine, made of Rhombus profile 22 x 70 mm, incl. cloth on the side walls, without base, larch tone pressure impregnated.

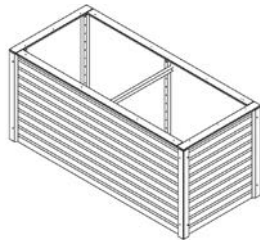

NEW



W x H x D in cm	180 x 80 x 80
Art.-Nr.	2201858084
VE	5

RAISED PLANTER IN 3 VARIATIONS

Building kit of planed boards approx. 18 mm thick (stepped bed 16 mm), incl. grid division and foil, green pressure impregnated.

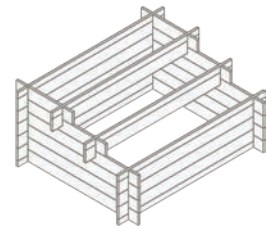
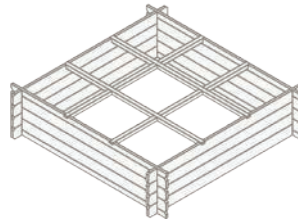
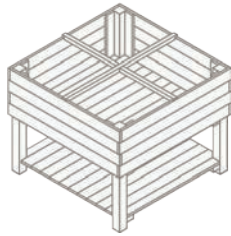

Model	Model A	Model B	Model C
L x W x H in cm	100 x 100 x 80	140 x 140 x 35	120 x 100 x 53
Art.-Nr.	2210100100	2210140140	2210120100
VE	4	4	4

COMPOSTER

Interlocking system made of rough sawn boards 16 mm thick, green pressure impregnated.



L x W x H in cm	100 x 100 x 70
Art.-Nr.	1604101070
VE	25

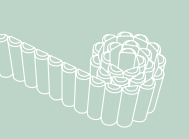

PLANTER FRANKFURT

Planter 89 x 43 x 138 cm, trellis with frame 42 x 42 mm, battens 9 x 25 mm, planed, chamfered, batten spacing approx. 12 cm, galvanized brackets, pine, green pressure impregnated, without planting foil.

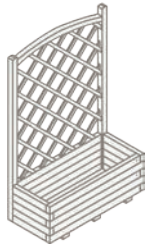

W x D x H in cm	89 x 43 x 138
Art.-Nr.	2390401400
VE	5



PLANTER MAINZ

Rectangular, made of untreated larch wood, Rhombus profile 22 x 70 mm, lined with cloth.

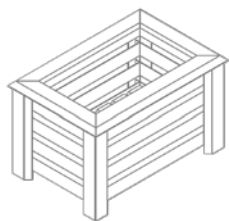

W x D x H in cm	60 x 40 x 36
Art.-Nr.	2280604035
VE	6

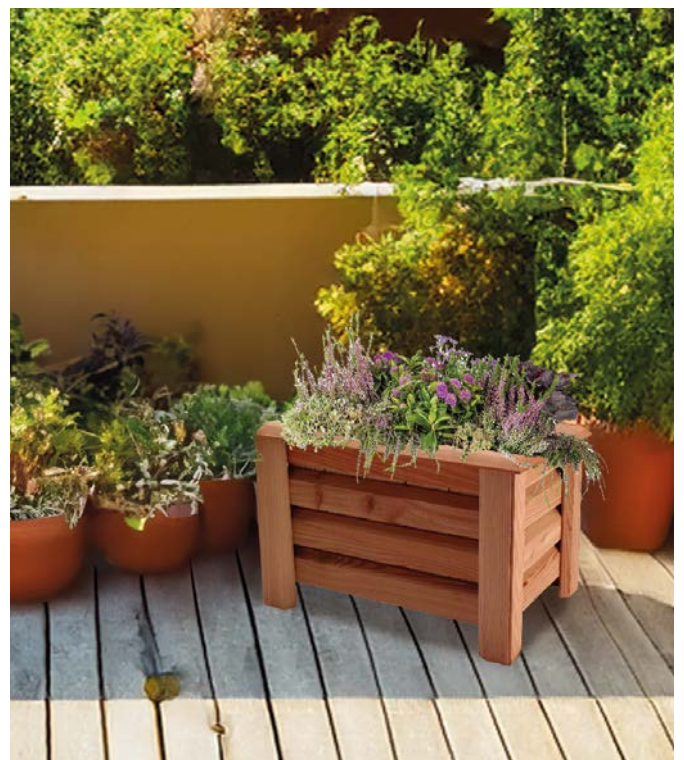

PLANTER BREMEN

Rectangular, made of 42 x 42 mm thick wood, pine, green pressure impregnated, incl. planting foil.

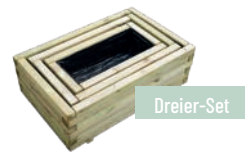

W x D x H in cm	60 x 30 x 20	71 x 41 x 24	82 x 52 x 28	Package 1x small, medium, large
Art.-Nr.	2244602230	2244712641	2244823152	2244445282
VE	8	6	4	8

PLANTER HAMBURG

Hexagonal, made of 42 x 42 mm thick wood, pine, green pressure impregnated, incl. planting foil.

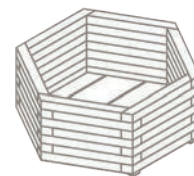
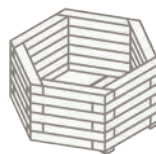
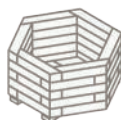

Ø x H in cm	48 x 22	60 x 26	80 x 30	Package 1x small, medium, large
Art.-Nr.	2218444824	2218446028	2218448032	2218242832
VE	8	8	8	8



OUR CONTRIBUTION TO CLIMATE PROTECTION

Sustainability, reliability, and responsibility are our core values. Among other things, we are PEFC certified. By following a 0% residual material standard, we make an active contribution to climate protection. Our pellets and briquettes are made exclusively from our by-products, such as sawdust and scrap wood. This means that no additional trees must be cut down for our fuel production. In addition, we consider sustainable forest management to be very important and our wood is exclusively resourced from nearby forests. This minimizes the energy consumption required for transportation and therefore helps reduce CO₂-emissions.

With the completion of our second ORC plant, we have managed to supply our entire production facility with self-generated electricity. This means that the production facility is completely independent of the constantly rising electricity prices on the market.

In addition to the generated electricity, both ORC plants produce waste heat, which is fully used to dry the wood chips to produce wood briquettes and wood pellets. The wood chips are now dried with belt dryers, significantly improving the quality and effectiveness of the drying process. The use and independent production of our energy makes an important contribution to climate protection.

WOOD BRIQUETTES

Our RUF briquettes are high-quality wood briquettes made from softwood, which are produced from by-products of our own sawmill. For this we use only branded presses from the German company RUF.

Packaging of 10 kg briquettes

One pallet = 96 packs of 10 kg

Environmentally friendly, it is CO²-neutral

Made of 100% pure wood with no binder

Heating value > 4,6 kWh/kg

Clean handling

PEFC certified

DIN 51 731

Art.-Nr. 1207198338



WOOD PELLETS

Since we only use by-products from our own sawmill to manufacture the pellets, we can offer very sustainably produced pellets for which no additional trees were cut down. The pellets with the certification are an environmentally friendly fuel resourced from sustainable forestry.

Plastic bag of 15 kg

One pallet = 70 bags of 15 kg

Quality grade: DIN plus / A1

Heating value > 4,6 kWh/kg

Dimension Ø 6mm

Low ash content (< 0,7 %)

Low moisture content (< 10%)

Environmentally friendly, it is CO²-neutral

An ecological standard fuel

PEFC certified

Art.-Nr. 2701025964



GOOD TO KNOW

Abb.1

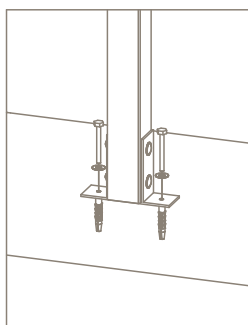
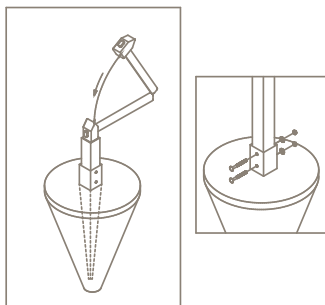
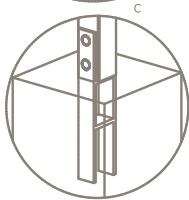
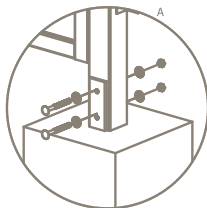
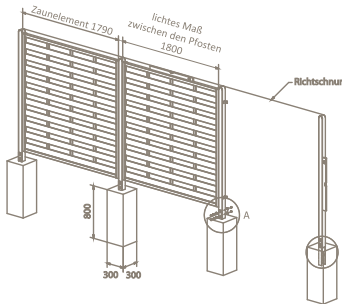
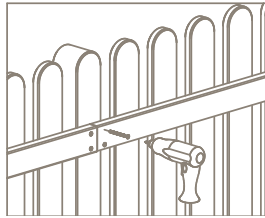

Installation tips for the fence area:

Front yard fences with crossbars

With these types of fences, the crossbars are screwed directly to the center of the posts from behind.

Privacy and front yard fences with surrounding frames:

These fence types should be fastened with four L-brackets between the posts (please pre-drill). Dimplex fences usually have so-called nominal dimensions. This means that the respective width is approx. 1 cm smaller than specified in the catalog. This means that the posts for an element with a width of, for example, 180 cm can also be set to a clear dimension of 180 cm (fence 179 cm plus 1 cm for the L-brackets on the left and right). The clear dimension is the distance between the posts, measured from inner edge to inner edge.

Installing the fence

We generally recommend placing the posts in H-anchors whenever possible. This ensures greater stability, and the post makes no contact with the ground. This increases the durability of the natural wood material. First determine the position of the posts and dig the holes for the foundations (approx. 30 x 30 x 80 cm). Before setting the anchors in concrete, the fence system should be aligned according to the drawings. Use a tensioning cord for longitudinal alignment.

The following alternative is available for fixing a post:

Drive-in ground sleeve:

Please strike it with a hammer into the ground.

Post anchor for mounting base:

For mounting on an existing wall etc. Please only use for front yard fences, not for privacy fences.

Tip: For wood protection reasons, a post rounded at the top or a post cover is recommended. There are various models available in terms of material and shape. Talk to your dealer!

Montagetipps für die Terrasse:

A gravel bed is recommended as a base, alternatively a so-called point foundation or, if already available, an area covered with paving slabs. Lay the substructure, we recommend our construction timber with a cross-section of 45 x 75 mm, with a maximum clearance of 50 cm. If possible, the substructure should be prefabricated as a frame. Make sure that the boards have a slope of at least 1 cm per running meter in the longitudinal direction so that the water can run off better, especially with grooved boards. Unevenness in the substrate can be evened out with rubber pads for paving slabs or point foundations. The boards should be screwed to the substructure with two stainless steel screws at a joint spacing of at least 5 mm when the wood moisture content is medium. The distance to the end of the board should be at least 40 mm and 20 mm to the edge of the board to prevent the wood from cracking. Please paint the cut edges with wood preservative!

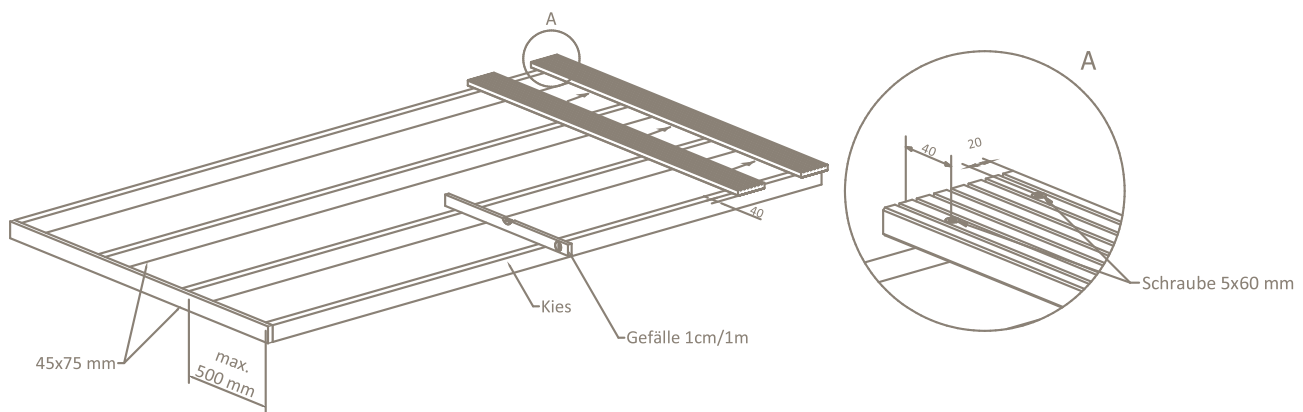

We recommend the following screws for fastening our floorboards:

board thickness	screw size
21 mm	5 x 50 mm
27 mm	5 x 60 mm
33 mm	5 x 70 mm

Please use stainless steel screws.

The following typical wood properties emphasize the naturalness of wood as a material and therefore do not constitute grounds for concern:

- isolated resin galls or resin leakage
- cracking due to swelling and shrinkage of the wood
- slightly rough spots, especially in the knot areas
- small drill holes caused by fresh wood insects

Tip: Line the base area with a plant or pond foil before starting installation. This prevents grass and weeds from growing through. Furthermore, supply lines for power connections etc. can be easily concealed under the decking boards. Repaint the decking boards at regular intervals depending on use and degree of weathering.

TYPES OF WOOD USED BY DIMPLEX

PINE

Originating from European forests, pine wood is characterized by its durability and longevity. The stability of our high-quality wood is further enhanced by appropriate pre-treatment. The special process of pressure impregnation is used for this. Chromium-free wood preservative salts are pressed deep into the raw wood under high pressure.

LARCH

The wood is very durable even without the pressure impregnation. To preserve the natural red coloring, we recommend a coat of pigmented glaze soon after installation.

IMPREGNATED OFFERING



GREEN IMPREGNATED



BROWN IMPREGNATED



VINTAGE-GREY IMPREGNATED



LARCH TONE IMPREGNATED

COLOR OFFERING



PINE COLOR STAINED



ANTHRACITE STAINED



**BASALT-GREY
2-LAYER STAINED**

MAINTENANCE INSTRUCTIONS

To maintain their value, fences should be repainted after installation or within the first three months at the latest. Our paints can be applied easily and effortlessly with an acrylic brush without leaving any marks or streaks. If the surface becomes matt or dull over time, we recommend re-treatment. Please clean the fence or posts beforehand and lightly roughen with 180 - 200 grit sandpaper.

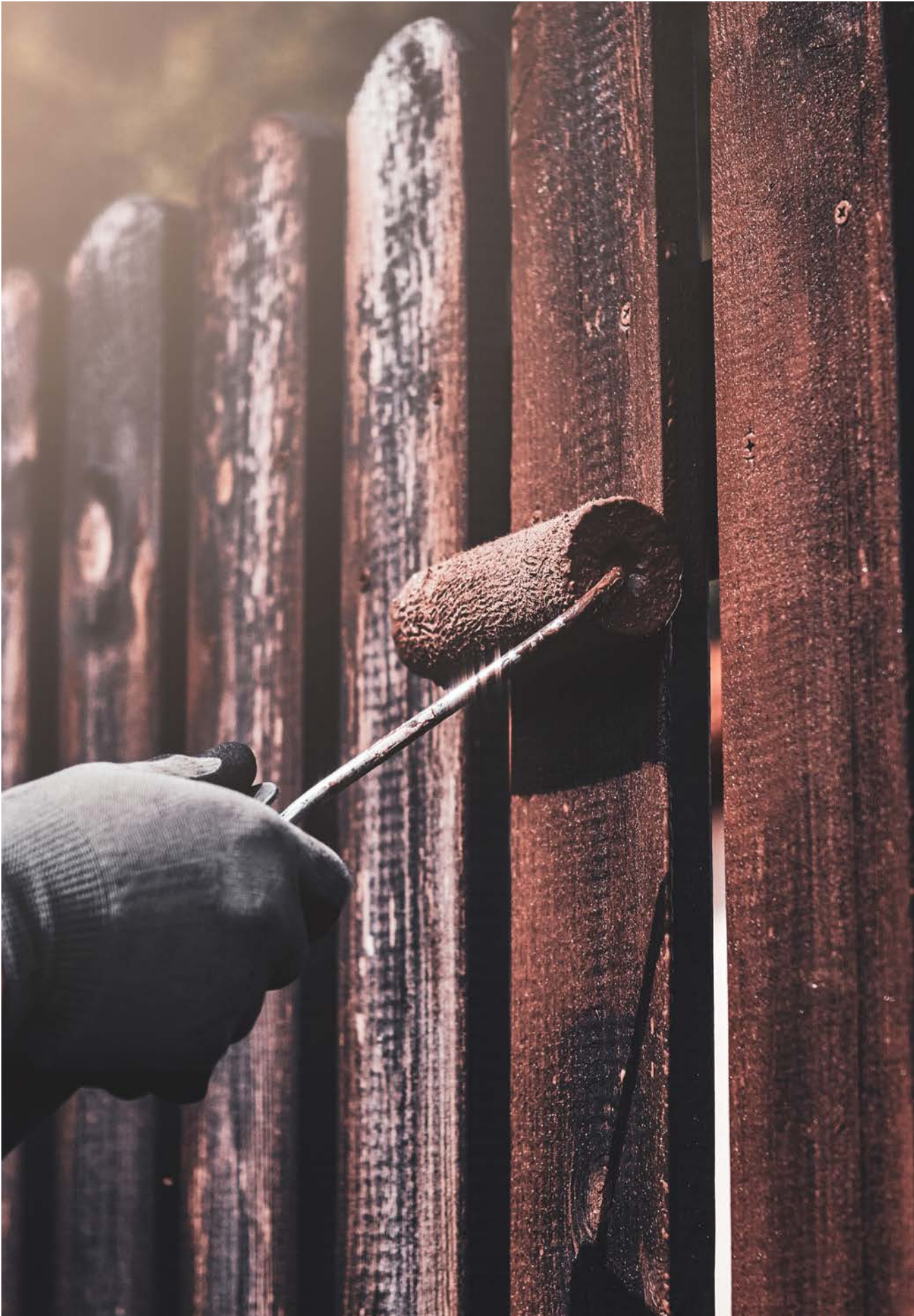

TYPICAL WOOD CHARACTERISTICS

Wood is a natural material with outstanding properties, such as high strength with good elasticity, easy processing and good sound insulation. Anyone who loves a natural look will be happy with the following properties of wood.



1. Swelling and shrinkage/cracking

Wood adapts to the surrounding humidity and thus changes its volume. This is referred to as swelling and shrinkage, also known as 'working' of the wood. Wood can shrink up to 8% tangentially to the annual rings, radially the value is significantly lower.



2. Resin leakage

Resin may leak out occasionally, especially in the first year after completion of the product. Resin becomes brittle on the surface relatively quickly and weathers off on its own over time. Alternatively, the hardened resin can also be scraped off.



3. Pith

Depending on the age of the tree, there is a more or less pronounced pith in the middle of the trunk. During the tree's lifetime, this is the supply channel and is sometimes mistaken for rot.



4. Knots and grains

Knots and the natural grain are a characteristic feature of wood and are not subject to any restrictions. They can vary greatly in number and size.

5. Rough spots / Fringes

Rough spots can occur, especially in the knot area, despite careful processing with sharp milling and planing tools. Also small fringes on chamfered items, such as palisades, cannot always be avoided.



6. Efflorescing salts

This is leaked resin on the surface that has been colored green/whitish by the pressure im-pregnation. These small stains weather off on their own over time or can usually be washed off.

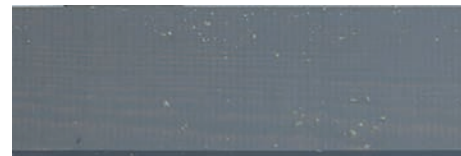

7. Small drill holes

These are usually caused by fresh wood insects. These die off before further processing and pose no danger to adjacent components.



8. Mold and blue stains

Pressure impregnated wood has a very high moisture content due to the process. This can lead to mildew stains or mold growth, especially in the warmer months of the year. These merely visual defects can usually be wiped off or weather off after a while. Mold and blue stain fungi do not destroy the wood and do not affect its strength.



Dimensions and prices

Due to swelling and shrinkage behavior and for production-related reasons, the dimensions stated in the catalog may vary slightly. We reserve the right to make technical changes. The prices are non-binding recommendations incl. 19% VAT, per item, without accessories, on collection. We reserve the right to make appropriate adjustments in the event of significant changes in exchange rates or raw material prices.



DIMPLEX GARTEN GMBH
WWW.DIMPLEX-GARTEN.DE
KONTAKT@DIMPLEX-GARTEN.DE